

ES

DESCRIPCIÓN

1. Silla giratoria con base de polipropileno en forma de estrella con ruedas y respaldo curvo para un óptimo confort. Pistón de gas regulable en altura. Versátil y resistente.

ESTRUCTURA

2. Plástico Polipropileno (60% es reciclado y 20% material nuevo) + 20% fibra de vidrio
3. Pistón de gas
4. Asiento tapizado opcional*
5. Base de polipropileno en forma de estrella con ruedas sin freno de Ø65mm

EN

DESCRIPTION

1. Polypropylene 5 stars base and waterfall seat chair. Stroke gas lift and adjustable weight. Great mobility and versatile. Versatile and durable.

STRUCTURE

2. Polypropylene plastic (60% recycled and 20% new material) + 20% fibreglass
3. Stroke gas lift
4. Optional upholstered seat*
5. Polypropylene star base with no brake castors Ø65mm

FR

DESCRIPTION

1. Chaise avec piètement en polypropylène 5 branches sur roulettes et dossier courbé pour assurer un excellent confort. Vérin à gaz réglable en hauteur. Grande mobilité et multifonction. Durable et multifonction.

STRUCTURE

2. Plastique polypropylène (60 % recyclé et 20 % nouveau matériau) + 20 % fibre de verre
3. Vérin à gaz
4. Assise rembourée en option**
5. Piètement en polypropylène 5 branches sur roulettes sans frein de Ø65mm



COLOR · COLOR · COULEUR

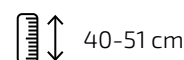
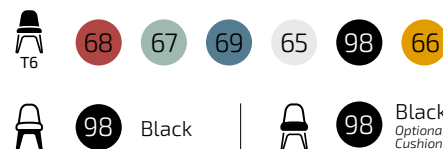

EMBALAGE · PACKAGING · EMBALLAGE

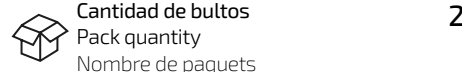

A. 56x66x42cm
B. 54,5x51x55cm

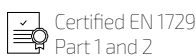
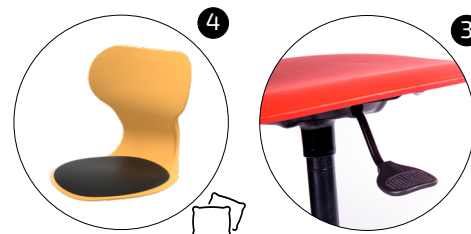

MEDIDAS · MEASUREMENTS · MESURES

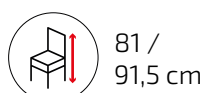

PESO · WEIGHT · POIDS

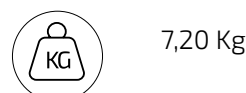

CAT

DESCRIPCIÓ

1. Cadira amb base de polipropilè i respall corbat per a un òptim confort. Gran mobilitat i versàtil. Pistó de gas regulable en altura. Versàtil i resistent.

ESTRUCTURA

2. Plàstic Polipropilè (60% és reciclat i 20% material nou) + 20% fibra de vidre
3. Pistó de gas
4. Seient tapissat opcional
5. Base de polipropilè en forma d'estrella amb rodes sense fre de Ø65mm

DE

BESCHREIBUNG

1. Polypropylen 5 Sterne Basis und Wasserfall Sitz Stuhl. Stroke Gas Lift und einstellbares Gewicht. Große Mobilität und vielseitig. Vielseitig und langlebig.

STRUKTUR

2. Kunststoff Polypropylen (60% ist recycelt und 20 % neues Material) + 20 % Fiberglas
3. Hub Gaslift
4. Optionaler gepolsterter Sitz*
5. Polypropylen-Sternfuß mit ungebremsten Rollen Ø65mm

IT

DESCRIZIONE

1. Sedia con base a 5 stelle in polipropilene e seduta a cascata. Alzata a gas a corsa e peso regolabile. Grande mobilità e versatilità. Versatile e resistente.

STRUTTURA

2. Plastica Polipropilene (60% è riciclato e 20% nuovo materiale) + 20% fibra di vetro
3. Sollevatore a gas a corsa
4. Sedile imbottito opzionale*
5. Base a stella in polipropilene con ruote senza freno Ø65mm



COLOR · FARBE · COLORE

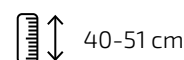
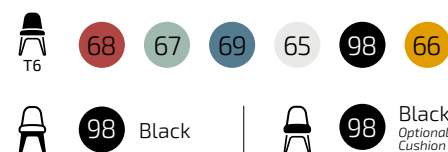

EMBALATGE · VERPACKUNG · IMBALLAGGIO

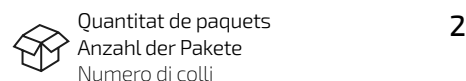

A. 56x66x42cm
B. 59x59x41,5cm

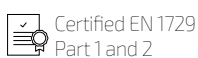
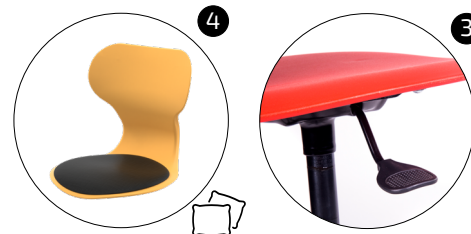

MESURES · MESSUNG · MISURAZIONE

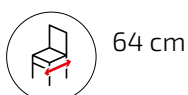
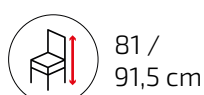















PES · GEWICHT · PESO



MIA LIFT

Combinaciones MIA / MIA Combinations / Combinaisons MIA
Combinacions MIA / MIA-Kombinationen / Combinazioni MIA

1035

Legs 96 RAL 9006									
 68	MIA BASIC 68	MIA CANTILEVER 68	MIA CASTORS 68	MIA MINI LIFT 68	MIA LIFT 68	MIA BIG LIFT 68	MIA STOOL 68	MIA STORE 68	MIA TABLE 68
 67	MIA BASIC 67	MIA CANTILEVER 67	MIA CASTORS 67	MIA MINI LIFT 67	MIA LIFT 67	MIA BIG LIFT 67	MIA STOOL 67	MIA STORE 67	MIA TABLE 67
 69	MIA BASIC 69	MIA CANTILEVER 69	MIA CASTORS 69	MIA MINI LIFT 69	MIA LIFT 69	MIA BIG LIFT 69	MIA STOOL 69	MIA STORE 69	MIA TABLE 69
 65	MIA BASIC 65	MIA CANTILEVER 65	MIA CASTORS 65	MIA MINI LIFT 65	MIA LIFT 65	MIA BIG LIFT 65	MIA STOOL 65	MIA STORE 65	MIA TABLE 65
 66	MIA BASIC 66	MIA CANTILEVER 66	MIA CASTORS 66	MIA MINI LIFT 66	MIA LIFT 66		MIA STOOL 66		
 98	MIA BASIC 98	MIA CANTILEVER 98	MIA CASTORS 98	MIA MINI LIFT 98	MIA LIFT 98	MIA BIG LIFT 98	MIA STOOL 98	MIA STORE 98	MIA TABLE 98



Mia BASIC 



Mia CANTILEVER 



Mia CASTORS 



Mia MINI LIFT 



Mia LIFT 



Mia BIG LIFT 



Mia STOOL 



Mia STORE 



Mia TABLE 



Ver productos
View Products
Voir les produits
Veure products
Produkte anzeigen
Visualizza i prodotti

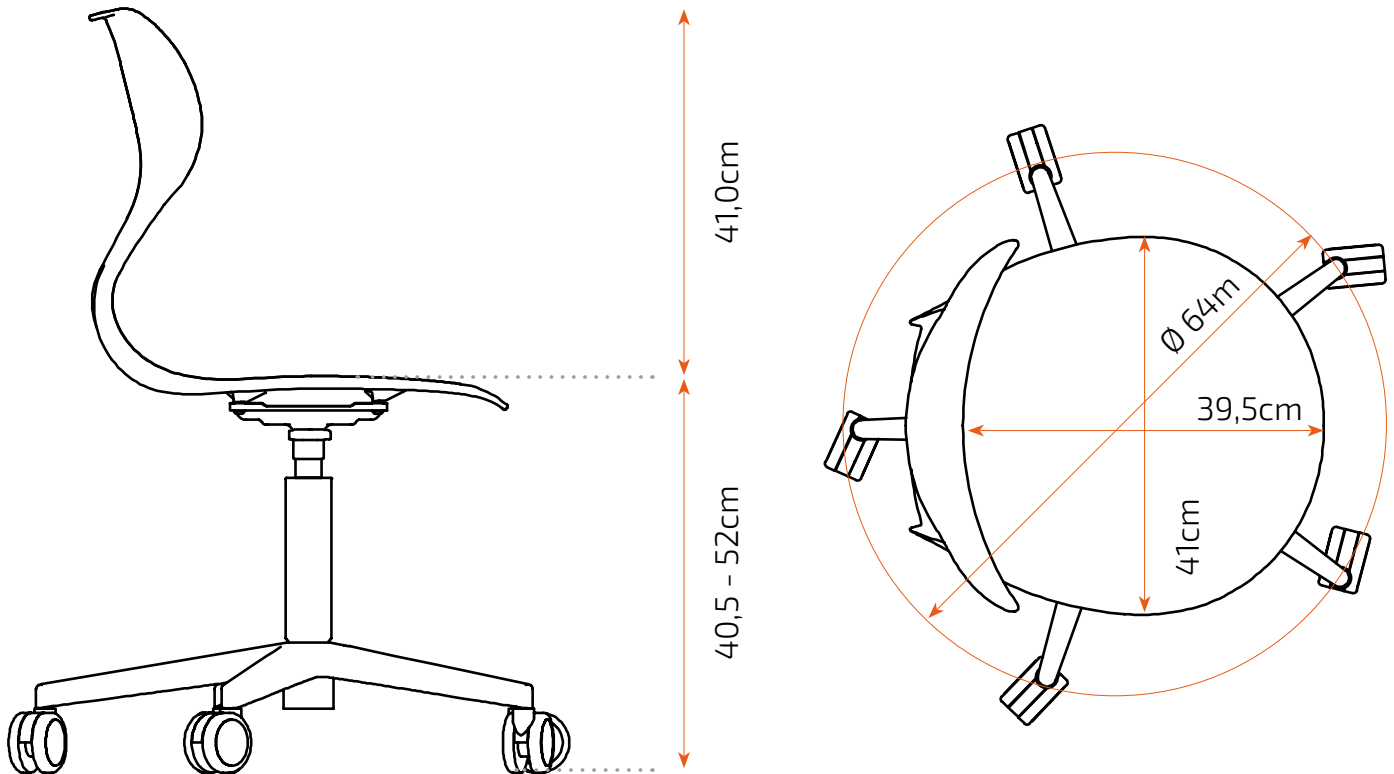

Guia de tallas / Size Guide / Guide des tailles
 Guia de tallas / Größentabelle / Guida alle taglie

TALLA / SIZE / TAILLE	A	B	C	D
0	1-2	80-95cm	21cm	40cm
1	2-3	93-116cm	26cm	46cm
2	3-4	108-121cm	30cm	52cm
3	4-6	119-142cm	34cm	59cm
4	6-8	133-159cm	38cm	65cm
5	8-10	146-176cm	42cm	70cm
6	+12	159-188cm	45cm	77cm
7	+14	174-207cm	51cm	82cm
8*	+8	+146cm	80cm	100cm

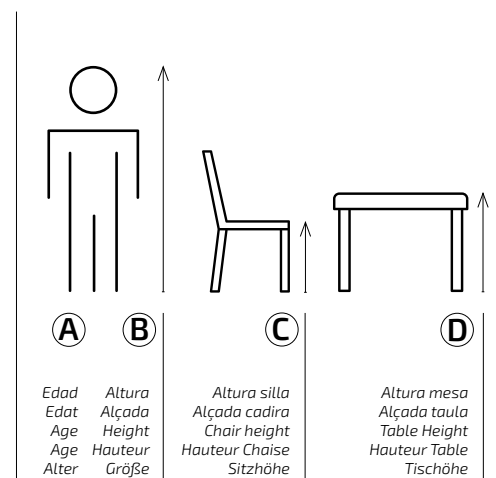

*Equivalent UNE-EN 1729-1 a dimensiones talla 5 para sillas altas y mesas de trabajo de pie
 *Equivalent UNE-EN 1729-1 size 5 dimensions for high chairs and standing work tables.
 *Equivalent UNE-EN 1729-1 aux dimensions de taille 5 pour les chaises hautes et les tables de travail debout.
 *Equivalent UNE-EN 1729-1 a dimensions talla 5 per a cadires altes i taules de treball dempeus.
 *Entspricht UNE-EN 1729-1Größe-5-Abmessungen für hohe Stühle und Steharbeitstische.

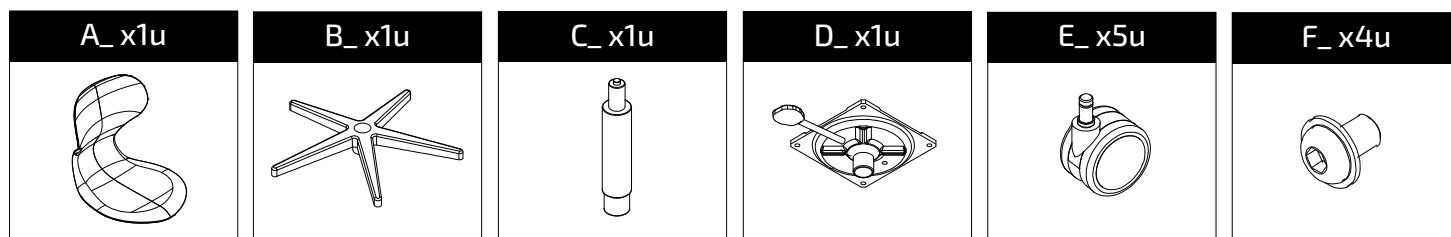

1

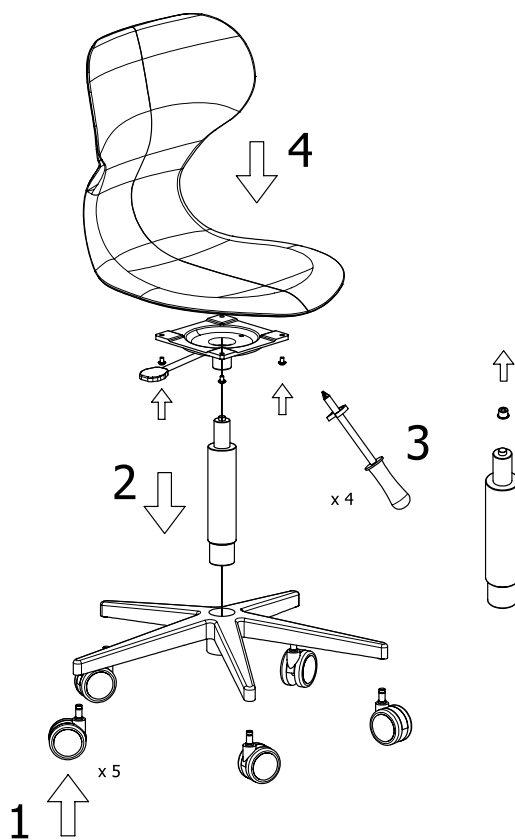

2



3

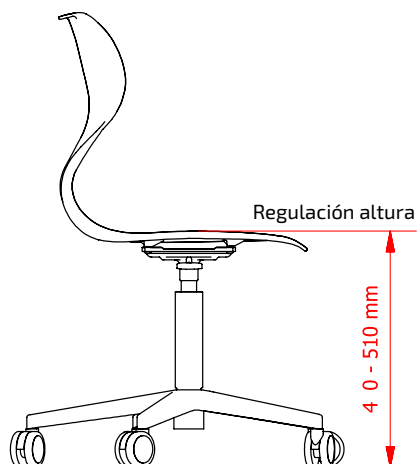

Información importante / Important Information / Informations importantes Informació important / Wichtige Informationen / Informazioni importanti

ES

INFORMACIÓN

Lea todas las instrucciones antes de comenzar el ensamblaje. Guarde las instrucciones para uso futuro. Uso interior.

ADVERTENCIA

Utilizar solo como se pretende.

MONTAJE

Seguir las instrucciones de montaje adjuntas.

MANTENIMIENTO

Periódicamente se deben realizar tareas de mantenimiento revisando el estado del producto. Verifique que el producto esté en buen estado y funcionando. Compruebe si hay roturas periódicamente. Retire el producto del servicio cuando se produzca alguna condición que pueda considerarse insegura.

CUIDADO Y LIMPIEZA

Limpie la unidad con un paño húmedo o una esponja con agua tibia y jabón suave. Séquelo. No use limpiadores abrasivos, blanqueadores, solventes químicos ni detergentes fuertes.

GARANTÍA

2 años de garantía limitada.

CAT

INFORMACIÓ

Llegeixi totes les instruccions abans de començar l'assemblatge. Guardeu les instruccions per a un futur ús. Ús interior.

ADVERTÈNCIA

Utilitzeu només segons el previst.

MUNTATGE

Seguiu les instruccions de muntatge adjuntes.

MANTENIMENT

S'han de realitzar tasques de manteniment periòdiques revisant l'estat del producte. Verifiqueu que el producte estigui en bon estat i funcioni correctament. Comproveu si hi ha trencaments periòdicament. Retireu el producte de l'ús quan es presenti alguna condició que pugui considerar-se perillosa.

CUIDAT I NETEJA

Netegeu la unitat amb un drap humit o una esponja amb aigua tèbia i sabó suau. Eixugueu bé. No utilitzeu netejadors abrasius, lleixius, solvents químics ni detergents forts.

GARANTIA

Garantia limitada de 2 anys.

EN

INFORMATION

Read all instructions before beginning assembly. Keep the instructions for future use. Indoor use.

WARNING

Use only as intended.

ASSEMBLY

Follow the attached assembly instructions.

MAINTENANCE

Periodic maintenance tasks should be performed by checking the condition of the product. Ensure the product is in good condition and functioning properly. Check for breaks regularly. Remove the product from service when any condition that could be considered unsafe occurs.

CARE AND CLEANING

Clean the unit with a damp cloth or sponge using warm water and mild soap. Dry thoroughly. Do not use abrasive cleaners, bleach, chemical solvents, or strong detergents.

WARRANTY

2-year limited warranty.

DE

INFORMATIONEN

Lesen Sie alle Anweisungen, bevor Sie mit dem Zusammenbau beginnen. Bewahren Sie die Anweisungen für die zukünftige Verwendung auf.

WARNUNG

Nur wie vorgesehen verwenden.

MONTAGE

Befolgen Sie die beiliegenden Montageanleitungen.

WARTUNG

Regelmäßige Wartungsarbeiten sollten durchgeführt werden, indem der Zustand des Produkts überprüft wird. Stellen Sie sicher, dass das Produkt in gutem Zustand ist und ordnungsgemäß funktioniert. Überprüfen Sie regelmäßig auf Brüche. Entfernen Sie das Produkt aus dem Gebrauch, wenn eine Bedingung vorliegt, die als unsicher angesehen werden kann.

PFLEGE UND REINIGUNG

Reinigen Sie die Einheit mit einem feuchten Tuch oder Schwamm mit warmem Wasser und mildem Seifenreiniger. Trocknen Sie gründlich ab. Verwenden Sie keine Scheuermittel, Bleichmittel, chemische Lösungsmittel oder starke Reinigungsmittel.

GARANTIE

2 Jahre eingeschränkte Garantie.

FR

INFORMATIONS

Lisez toutes les instructions avant de commencer l'assemblage. Conservez les instructions pour une utilisation future. Utilisation intérieure.

AVERTISSEMENT

Utiliser uniquement comme prévu.

ASSEMBLAGE

Suivez les instructions de montage ci-jointes.

ENTRETIEN

Des tâches d'entretien périodiques doivent être effectuées en vérifiant l'état du produit. Assurez-vous que le produit est en bon état et fonctionne correctement. Vérifiez régulièrement s'il y a des bris. Retirez le produit du service lorsqu'une condition pouvant être considérée comme dangereuse se présente.

ENTRETIEN ET NETTOYAGE

Nettoyez l'unité avec un chiffon humide ou une éponge à l'eau tiède et au savon doux. Séchez soigneusement. N'utilisez pas de nettoyeurs abrasifs, d'eau de Javel, de solvants chimiques ou de détergents puissants.

GARANTIE

Garantie limitée de 2 ans.

IT

INFORMAZIONI

Leggere tutte le istruzioni prima di iniziare il montaggio. Conservare le istruzioni per un uso futuro. Uso interno.

AVVERTENZA

Utilizzare solo come previsto.

MONTAGGIO

Seguire le istruzioni di montaggio allegate.

MANUTENZIONE

È necessario eseguire periodicamente attività di manutenzione controllando lo stato del prodotto. Assicurarsi che il prodotto sia in buone condizioni e funzioni correttamente. Controllare periodicamente la presenza di rotture. Rimuovere il prodotto dall'uso quando si presenta una condizione che potrebbe essere considerata insicura.

CURA E PULIZIA

Pulire l'unità con un panno umido o una spugna con acqua tiepida e sapone neutro. Asciugare bene. Non utilizzare detersivi abrasivi, candeggina, solventi chimici o detersivi forti.

GARANZIA

Garanzia limitata di 2 anni.



Futuras actualizaciones
Future updates
Mises à jour futures

Futures actualitzacions
Zukünftige Aktualisierungen
Aggiornamenti futuri



Calidad certificada
Certified quality
Qualité certifiée

Qualität certificada
Zertifizierte Qualität
Qualità certificata



Mirplay colabora con la ong:
Mirplay collaborates with ngo:
Mirplay participe à l'ong:

Mirplay collabora amb l'ong:
Mirplay arbeitet mit der ngo zusammen:
Mirplay collabora con l'ong: